

HDMI 1.4 4K seamless 16x16 Matrix Switching User Operation Guide

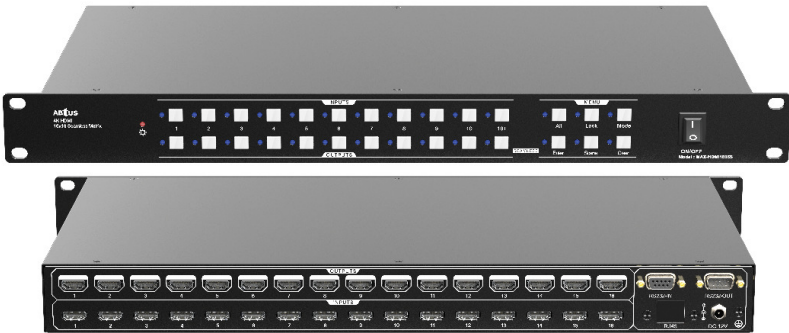

Model:
MAX-HDMI1616S

rev.2025.12Dec.15

User Operation Guide

OVERVIEW

The MAX-HDMI1616S is a professional 16x16 HDMI 1.4 Seamless Matrix Switcher with EDID management. It includes 16 HDMI inputs, 16 HDMI outputs. The matrix switcher features comprehensive EDID management to ensure maximum functionality with a wide range of video sources.

The matrix switcher supports RS-232 control options.

PRODUCT FEATURES

- Supports seamless and fast switching from multiple inputs to multiple outputs.
- Supports HDMI/DVI for both inputs and outputs, supports resolution up to 3840x2160@30Hz.
- Input and output color space support RGB4:4:4, YCbCr4:4:4, YCbCr4:2:2, etc..
- Built-in 7 different EDID for inputs, default 1920x1080@60Hz 2ch, supports user defined.
- Input is compatible with DVI / HDMI signal.
- Output support combo port default 9 output resolutions selectable.
- Output signal combination port format support HDMI, DVI.
- Support low power consumption standby and power cut off memory.
- Supports continuous hot-plugging and unplugging of HDMI interface.
- Support two-way serial port control, panel key control, optional network port control.
- 1U height 19-inch standard cabinet mount chassis

PANEL DESCRIPTION

Front Panel

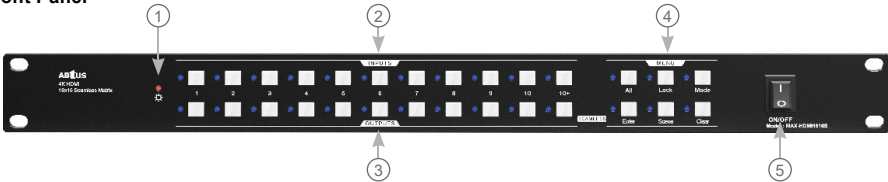

No	Name	Function description
1	Power indicator light	<ul style="list-style-type: none"> • The equipment is working normally, and the indicator light is always red; • In standby mode, the indicator light is off; • Power off, indicator light off
2	INPUTS	White input channel switch button;
3	OUTPUTS	White output channel switch button;
4	MENU function button area	<p>All: Select All button</p> <ul style="list-style-type: none"> • Switch one input signal to all output channels; <p>Lock:</p> <ul style="list-style-type: none"> • Lock: Press and hold the lock button for 3 seconds. • Unlock: Press and hold for 3 seconds to unlock the button. <p>Mode: Scene Save: →Mode+INPUTS 1+Enter</p> <p>ENTER: Confirm operation.</p> <p>SCENE: Scene call button to call the scene.</p> <p>CLEAR: Clear button to clear an unfinished action.</p>
5	ON/OFF switch	Power on/off

Attention: The product pictures are for reference only, please refer to the actual product

User Operation Guide

PANEL DESCRIPTION

Rear Panel

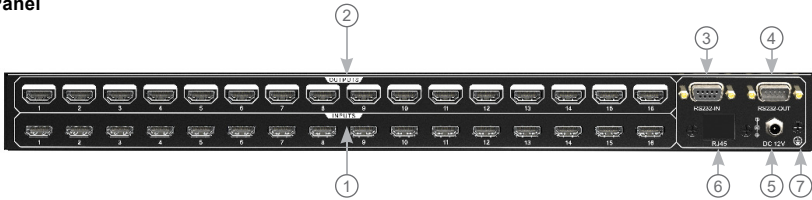

No	Name	Function description
1	INPUTS	HDMI input port, connecting to HDMI signal source, automatically detecting connection status;
2	OUTPUTS	HDMI output port, connected to display, automatically detecting connection status;
3	RS232 IN	Connect control devices, such as PC computers, and control the local computer through upper computer software;
4	RS232 OUT	Connect other peripherals, such as matrices, splicers, etc., to control peripherals
5	Power interface	Connect the power supply DC12V;
6	RJ45 (Reserved)	Optional, enhanced support for network control.
7	Grounding terminal	Grounding terminal

Attention: The product pictures are for reference only, please refer to the actual product

SYSTEM OPERATIONS

1. Panel Switching Control

The front panel buttons consist of channel buttons and function buttons, which can be used to control the machine, such as signal switching and scene calling.

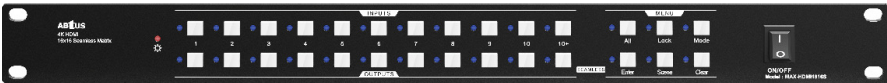

1.1. Signal switching

This machine includes multiple input channels and multiple output channels, and can switch any one input signal to one output or all channel outputs. The operation method is as follows:

1) **To convert 1 input to 1 output:**

Example: Input 1 to Output 2

→ Press **INPUTS 1 + OUTPUTS 2 + ENTER** button.

2) **To convert 1 input to ALL outputs:**

Example: Input 1 to ALL

→ Press **INPUTS 1 + ALL** button.

3) **To convert 1 input to 2~3 outputs:**

Example: Input 1 to Output 2, Output 3, Output 4.

→ Press **INPUTS 1 + OUTPUTS 2, Output 3, Output 4 + ENTER** button.

1.2. Scenario Management

Save Scene

Example: → Press **Mode + INPUTS 1 + ENTER** button. Supports 4 groups of scenes.

Scene Recall

Example: → Press **Scene + INPUTS 1 + ENTER** button. Supports 4 groups of scenes.

1.3. Clear outstanding operations

Please press the CLEAR button if want to withdraw an operation before the ENTER button comes into effect, meanwhile, the matrix will return to the previous status.

1.4. LOCK Function

Long press the LOCK button for three seconds, all buttons on the front panel disable to work. And then long press the LOCK button for three seconds again or unlock on GUI control, the front panel button will unlock.

User Operation Guide

SYSTEM OPERATIONS

2. Serial Port Control

The Seamless HDMI Matrix Switch is connected to the control computer, and the Seamless HDMI Matrix Switch can be controlled by the RS232 serial port software, the RS232 IN port is a 9-pin female connector, and the RS232 OUT port is a 9-pin male connector; the RS232 OUT1 port is a network port, and the pin descriptions are as follows:

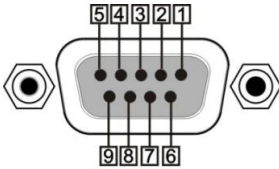

DB9 Female head

Pin	Name	Function
1	N/u	null
2	Tx	Send
3	Rx	Receive
4	N/u	null
5	Gnd	GND
6	N/u	null
7	N/u	null
8	N/u	null
9	N/u	null

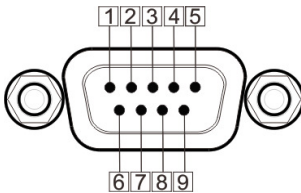

DB9 Male head

Pin	Name	Function
1	N/u	null
2	Rx	Receive
3	Tx	Send
4	N/u	null
5	Gnd	GND
6	N/u	null
7	N/u	null
8	N/u	null
9	N/u	null



RJ45

Pin	Colour	Function
1	Orange White	null
2	orange	null
3	Green White	Send
4	blue	GND
5	Blue White	GND
6	green	Receive
7	Brownish white	null
8	Brown	null

SYSTEM OPERATIONS

2.1. RS232 Instruction

Communication protocol: Default baud rate: 115200 Data bits: 8 Stop bits: 1 Check bits: None

- 1) The instructions include host function settings, channel switching, status query, output resolution settings, and other operations. Please refer to the instruction table for details.
- 2) In the following instructions, "[" and "]" are non sending characters, and ";" and "." cannot be omitted. Additionally, in the instructions, "()", characters, and punctuation are input in English input mode;
- 3) Pay attention to distinguishing between uppercase and lowercase in instructions;
- 4) Please note that certain instructions are set for different ports and have been clearly marked in the corresponding instruction function description section;
- 5) Some instructions may have different feedback code information depending on the device status, and the article only provides examples of feedback information;

2.2. Host Control Commands

RS232 instruction	Function Description	Return code	Remarks
(Stand by)	system standby	System off OK	
(wakeup)	System wake-up	System on OK	
(reset)	Restore factory settings	Factory reset OK	
(info, dev)	Query device information	MAX-HDMI1616S System on Unlock OK	
(info, link)	Query port connection status	Ch 1 2 3 4 In Y Y N N Out Y Y N N OK	
(ver)	Version Query	Mcu ctrl v1.0.0 OK	

User Operation Guide

SYSTEM OPERATIONS

RS232 instruction	Function Description	Return code	Remarks
(rename, product, [param])	Set product name Param=MAX-HDMI1616S	Product name: MAX-HDMI1616S OK	Example: (rename, product, MAX-HDMI1616S)
(lock, [param])	Key lock Param=0~1	Lock OK	Example: (lock, 1)
(lock, [param])	1=lock 0=unlock	Unlock OK	Example: (lock, 0)
(update, edid, [param])	Write custom EDID Param 1-4 1. Custom 1 2. Custom 2 3. Custom 3 4. Custom 4	Please send edited file in 15s Okay Edid 1 updated OK	Example: (update, edid, 1) Overtime feedback: Edid update time out OK

SYSTEM OPERATIONS

RS232 instruction	Function Description	Return code	Remarks
(edid, config, [inch], [param])	Calling EDID Inch=1-16 Param=1-11 1. 1024x768@60Hz Dual channel 2. 1280x720@60Hz Dual channel 3. 1360x768@60Hz Dual channel 4. 1920x1200@60Hz Dual channel 5. 1600x1200@60Hz Dual channel 6. 1920x1080@60Hz Dual channel (default) 7. 3840x2160@30Hz Dual channel 8. Custom 1 9. Custom 2 10. Custom 3 11. Custom 4	In 1 edid 1 OK	Example: (edid, config, 1,1)

SYSTEM OPERATIONS

RS232 instruction	Function Description	Return code	Remarks
(get, sw)	Query switching status	Out 1 in 1 Out 2 in 1 Out 3 in 1 Out 4 in 1 OK	
(get, i.res, [inch])	Obtain the current resolution of the input Inch=1-16	In 1 res 1280x720@60Hz OK	Example: (get, i.res, 1)
(scene, save, [Param])	Save Scene Param=Scene number (1-32)	Scene 1 saved OK	Example: (scene, save, 1)
(scene, call, [Param])	Call scenario Param=Scene number (1-32)	Scene 1 called OK	Example: (scene, call, 1)
(scene, del, [Param])	Scene deletion Param=Scene number (1-32)	Scene 1 deleted OK	Example: (scene, del, 1)
(set, o.format, [outch], [mode])	Set output signal format Outch=1-16 Mode=0-HDMI Mode=1-DVI	Output hdmi 1 format is hdmi OK	Example: (set, o.format, 1,0)
(get, o.format, [outch])	Query output signal format Outch=1-16	Output hdmi 4 format is HDMI OK	Example: (get, o.format, 4)
(get, o.res, [outch])	Query output resolution Outch=1-16	Out 1 res 1920x1200@60Hz OK	Example: (get, o.res, 1)

User Operation Guide

SYSTEM OPERATIONS

RS232 instruction	Function Description	Return code	Remarks
(set, o.res, [outch], [param])	Set output resolution Outch =1~16 Param=1-12 1. 1920x1200@60Hz 2. 1920x1080@60Hz 3. 1280x720@60Hz 4. 1360x768@60Hz 5. 1280x1024@60Hz 6. 1024x768@60Hz 7. 1600x1200@60Hz 8. 1440x900@60Hz 9. 1600x900@60Hz 10. 1280x720@50Hz 11. 1920x1080@50Hz 12. 3840x12160@30Hz	Out 1 res 1920x1200@60Hz OK	Example: (set, o.res, 1,1)
(set, i.baud, [param])	Set input RS232 baud rate Param=1~5 1. 9600 2. 19200 3. 38400 4. 57600 5. 115200 (default)	In baudrate 9600 OK	Example: (set, i.baud, 1)
(get, i.baud)	Query input RS232 baud rate	In baudrate 9600 OK	

SYSTEM OPERATIONS

RS232 instruction	Function Description	Return code	Remarks
(set, o.baud, [param])	Set output RS232 baud rate Param=1~5 1. 9600 2. 19200 3. 38400 4. 57600 5. 115200 (default)	Out baudrate 115200 OK	Example: (set, o.baud, 5)
(get, o.baud)	Query output RS232 baud rate	Out baudrate 115200 OK	
(set, uart, [param])	Set serial port control mode Param=1 Both RS232 in and out can control this machine	RS232 mode: in&out control local OK	Example: (set, uart, 1)
	Set serial port control mode Param=2 RS232 in control can control local or RS232 in → RS232 out Control Third Party	RS232 mode: in control local&out OK	Example: (set, uart, 2)

User Operation Guide

SYSTEM OPERATIONS

3. Client Control

3.1. Software Installation

Control software: Contact the supplier to obtain it.

- Installation: Copy the control software installation package to the control computer, double-click the upper computer installation file, and follow the prompts to install the client software;
- Uninstall: Click on the start menu, find this control software in the "Programs and Features" section of the control panel, select it, right-click, and choose to uninstall this software. Finally, follow the instructions to uninstall this control software.

3.2. Login

- 1) Double click on the matrix controller control software to open the upper computer software and enter the login interface
- 2) Click on "Connection Settings" to enter the connection settings interface
- 3) Select the control method "TCP/IP" or "COM port", and the default is COM connection.
- 4) Click on the 'Remember Password' option to log in again without entering the password again.
- 5) Click 'Exit' to exit the login interface.

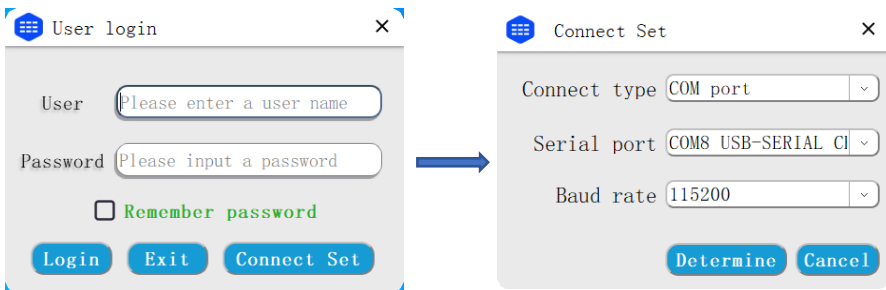

The default administrator account is admin, and the default password is "123456". For the user account, the default password is "123". If you need to modify the password, please go to the user management interface for operation. The login interface includes four parts of operation settings: remember password, login, exit, and connection settings.

Description: This machine supports 9600, 19200, 38400, 57600, and 115200, and can be set through command switching.

SYSTEM OPERATIONS

3.3. Software Operation

After logging in and connecting to the software, enter the main interface, as shown in the following figure:

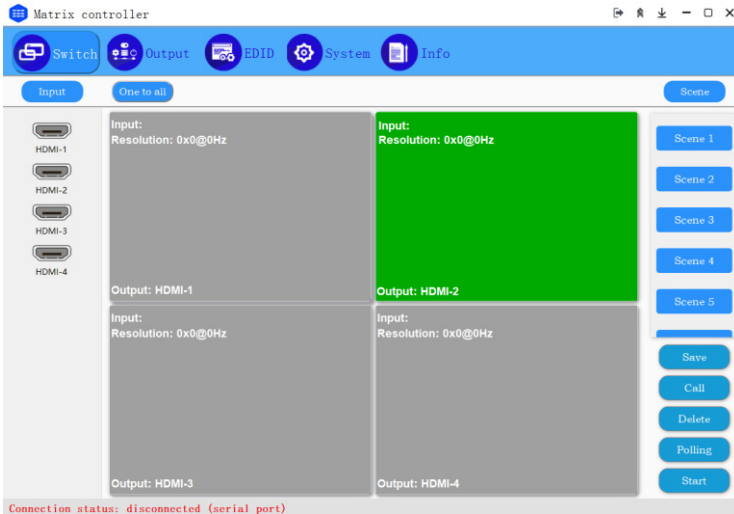

1. Menu bar: mainly includes 5 operation interfaces, including "Signal Switching", "Output Settings", "EDID Settings", "System Settings", and "System Information";
2. Input list: contains 1-4 input operable buttons;
3. Status display: displays the current connection status and control method;
4. Operation interface: The operation interface is divided into 1-4 output status information displays, with each display window displaying the current switched status information and the resolution of the current input signal source;
5. Scene list: mainly includes functions such as "scene save", "scene call", "scene delete", and scene polling settings;

User Operation Guide

SYSTEM OPERATIONS

3.3.1. Signal Switching Interface

The signal switching interface mainly involves switching between input signal sources, scene saving, calling, and scene polling operations.

- **Signal switching method:**

1. Directly selecting the corresponding input and clicking on the output end of the operation interface can achieve switching from one input to one output or from one input to multiple outputs.
2. Simply select the corresponding input and click "One to All" to switch from one input to all outputs.

- **Scenario operation method:**

Can save 1-16 scenes and call saved scenes at will

- **Scene save:**

Directly click on the scene button in the list and corresponding click on the scene save to achieve the scene save function.

- **Call scenario:**

Directly clicking on the saved scene button corresponds to clicking on the scene call to achieve scene call

- **Scenario deletion:**

Simply click on the saved scene button corresponding to the scene deletion button to achieve scene deletion

- **Scenario Polling:**

1. Click directly to enter the polling settings, add existing scenes to the polling scene list, set the time interval, and confirm to save.
2. Click on "Start Polling" to implement the scene polling function.

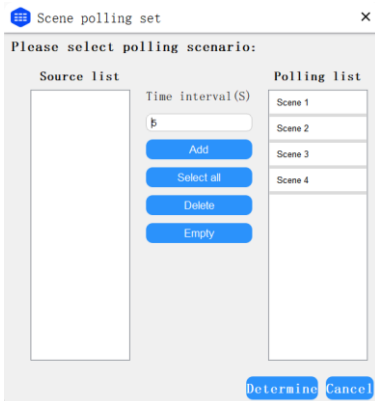

SYSTEM OPERATIONS

3.3.2. Output Setting

The output setting interface mainly allows for setting the resolution, output signal format, and brightness contrast function settings of the output end.

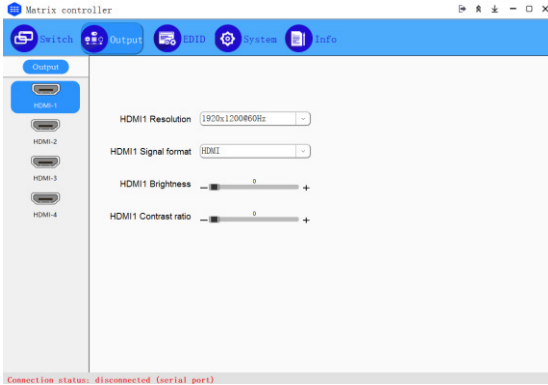

3.3.3. EDID Settings

The EDID setting interface can call or learn built-in, customized, and output EDID data to the input end.

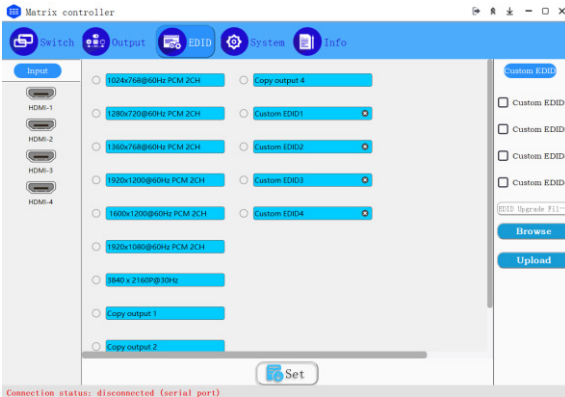

📖 Explanation:

1. 7 built-in EDIDs
2. Copy Output 1 to Copy Output 4 are the EDID data of the output end.
3. 'Custom EDID1'~'Custom EDID4' are customizations that require uploading the EDID file data before being called

User Operation Guide

SYSTEM OPERATIONS

3.3.4. System Settings

This operation interface includes 5 settings interfaces, namely: "Model Settings", "User Management", "Connection Settings", "Firmware Upgrade", "Device Control", "Language Settings", and "Channel Naming".

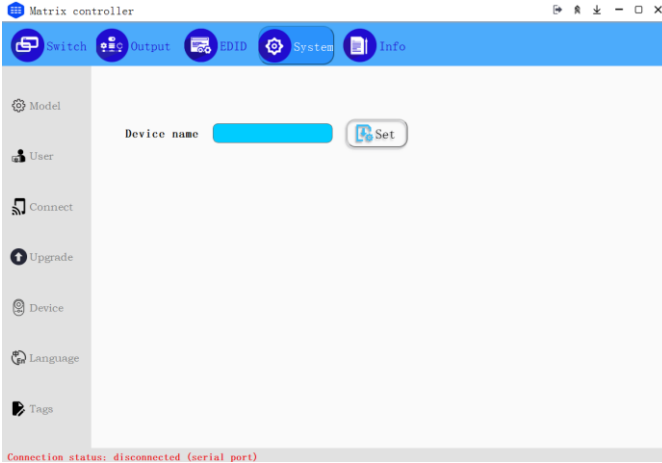

1. Model setting: Modify the device name.
2. User management: For modifying administrator accounts and ordinary user account passwords, etc.
3. Connection settings:
 - IP Setting: Set IP related parameters.
 - Serial port setting: Set the baud rate for RS232 input and RS232 output.
4. Firmware upgrade: Upgrade the device microcontroller program online.
5. Device control: includes 5 function keys, namely: "Restore to factory", "System standby", "System wake-up", "Key lock", "Key unlock". Click on the above function keys to achieve the function.
6. Language selection: Modify the upper computer language version to support both Chinese and English.
7. Channel naming: can name input and output scenes

Explanation:

- 1) Devices without network ports do not support IP related settings, please do not operate.
- 2) RS232 input and output baud rates cannot be modified simultaneously;
- 3) Both administrator and regular user names cannot be modified.

SYSTEM OPERATIONS

3.3.5. System Information

The system information includes two operation interfaces: "Port Status" and "About".

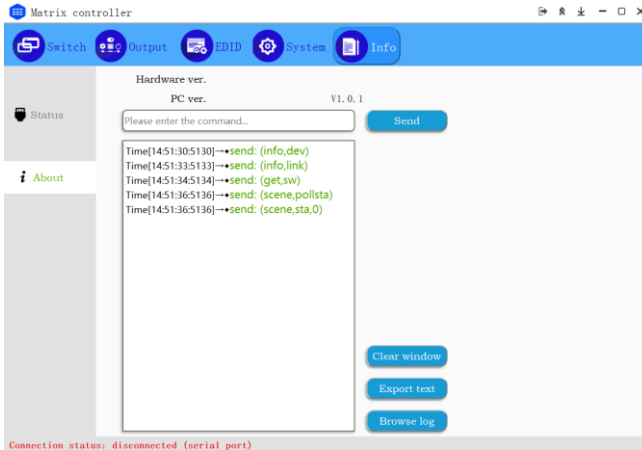

1. Port status: Display the connection status and current resolution of the input terminals (HDMI1~HDMI4) on the operation interface, and display the connection status and current resolution of the output terminals (HDMI1~HDMI4).
2. About: The interface displays the software and hardware version information currently used by the device. The operation bar below the version information can be used as a serial port tool to send instructions for control and display feedback information.
3. Clear Window: Clear the feedback information displayed on the interface.
4. Export Text: Export the record of the current operation. If there are any abnormalities, it is convenient for R&D personnel to troubleshoot problems.
5. View log: Similar to text, you can view operation records.

Explanation:

The port status interface cannot automatically monitor the connection status and current resolution. You need to manually click the "Refresh Port Status" button on the interface.

User Operation Guide

DIAGRAM

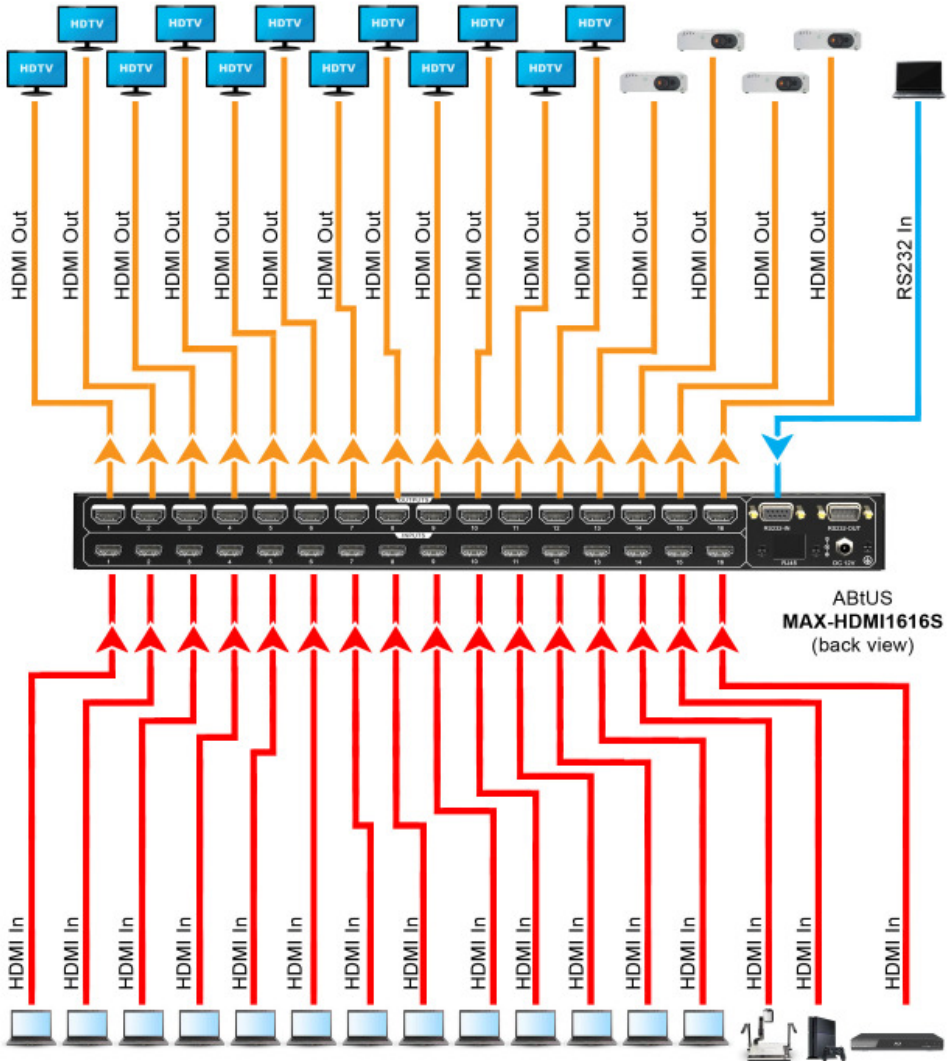

TECHNICAL SPECIFICATIONS

Video

Input	16 x HDMI
Input Connector	16 x Type-A female HDMI
Input HDMI Resolution	Up to 4K@30Hz RGB4:4:4, YCbCr4:4:4, YCbCr4:2:2
Output	16 x HDMI
Output Connector	16 x Type-A female HDMI
Output HDMI Resolution	Up to 4K@30Hz RGB 4:4:4,
HDMI Standard	1.4
HDCP Version	1.3
HDMI Embedded Audio	PCM

Control

Control Port	1 x RS232 in, 1 x RS232 out
Port Connector	1 x DB9 RS232 input female connector, 1 x DB9 RS232 output male connector,
Keys	White button (Supports switching and scene calling)

General

Transmission Distance	1080P ≤ 15m; 4K ≤ 5m;
Bandwidth	10.2Gbps
Working Temperature	0°C~+40°C
Storage Temperature	-10°C~+50°C
Relative Humidity	10%~90%
Power Supply	DC 12V 5A
Size (W*D*H)	437mm x 236mm x 44mm
Net weight	About 3.5 kg

